

Manual de Montagem



Leia antes de usar e guarde este manual para futuras consultas.



DESCRIÇÃO	QUANTIDADE
PARAFUSO SEXTAVADO (1)	40
PORCA SEXTAVADA (2)	40
ACABAMENTO DO CABO (3)	02
RODÍZIO DE PLACA (4)	04
CORREDIÇA DIREITA (5)	01
CORREDIÇA ESQUERDA (6)	01
PINO DOBRADIÇA (7)	04
ARRUELA DOBRADIÇA (8)	04

Tabela 1 – Componentes

3. Materiais



Figura 2 – Materiais

1. Estrutura completa



2. Componentes

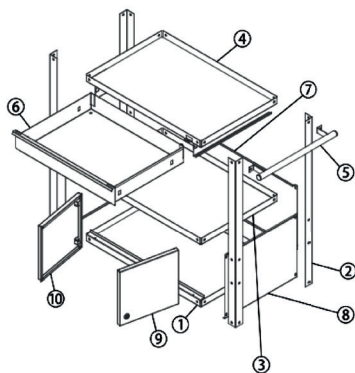
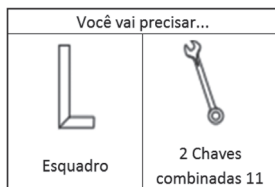

Figura 1 – Componentes

DESCRIÇÃO	QUANTIDADE
BANDEJA INFERIOR (1)	01
COLUMNAS (2)	04
BANDEJA INTERMEDIÁRIA (3)	01
BANDEJA SUPERIOR (4)	01
CABO (5)	01
GAVETA (6)	01
FECHAMENTO POSTERIOR (7)	01
FECHAMENTO LATERAL (8)	02
PORTA DIREITA (9)	01
PORTA ESQUERDA (10)	01

Tabela 2 – Materiais

4. Montagem

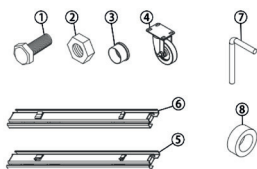
4.1. Bandeja inferior e laterais



Figura 3 – Montagem bandeja inferior e laterais

4.2. Montagem bandeja intermediária

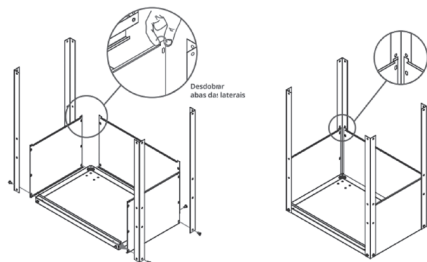

Figura 4 – Montagem bandeja intermediária

4.3. Montagem bandeja superior e cabo

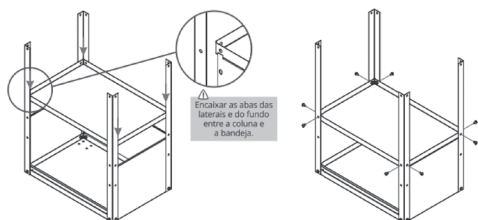

Tabela 3 – Montagem bandeja superior e cabo

5. Montagem gaveta

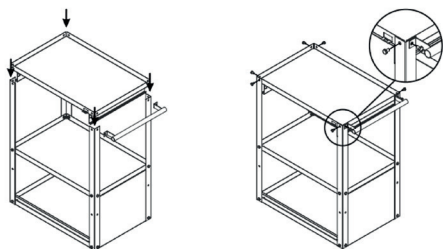

Figura 5 – Montagem da gaveta

6. Montagem portas e rodízios

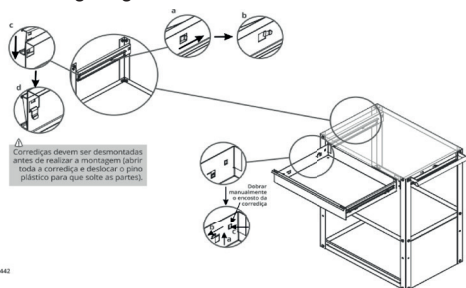

Figura 6 – Montagem portas e rodízios

7. Montagem concluída

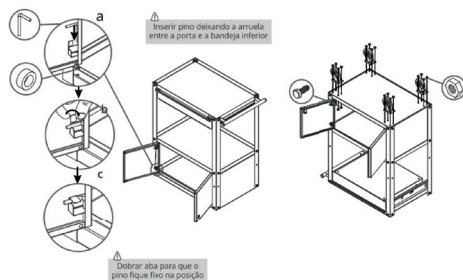

Figura 8 – Montagem concluída

Manual de Montaje



Lea antes de usar y guarde este manual para futuras consultas.

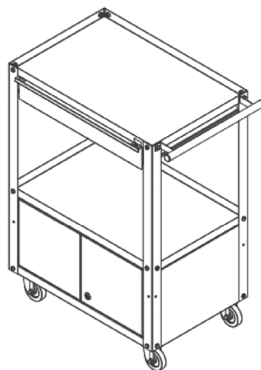

1. Estructura completa



2. Componentes



Figura 1 – Componentes

DESCRIPCIÓN	QUANTIDADE
TORNILLO HEXAGONAL (1)	40
TUERCA HEXAGONAL (2)	40
ACABAMIENTO DEL MANGO (3)	02
RODADO DE PLACA (4)	04
CORREDIZA DERECHA (5)	01
CORREDIZA IZQUIERDA (6)	01
PASADOR BISAGRA (7)	04
ARANDELA BIZAGRA (8)	04

Tabla 1 – Componentes

3. Materiales

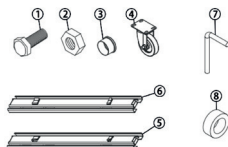

Figura 2 – Materiales

DESCRIPCIÓN	QUANTIDADE
BANDEJA INFERIOR (1)	01
COLUMNAS (2)	04
BANDEJA INTERMEDIARIA (3)	01
BANDEJA SUPERIOR (4)	01
MANGO (5)	01
CAJONERA (6)	01
CIERRE POSTERIOR (7)	01
CIERRE LATERAL (8)	02
PUERTA DERECHA (9)	01
PUERTA IZQUIERDA (10)	01

Tabla 2 – Materiales

4. Montaje

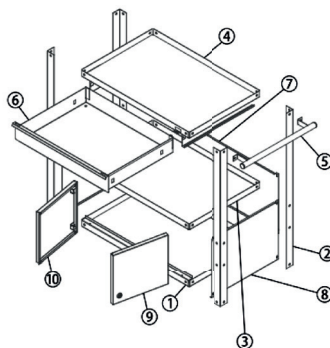
4.1. Bandeja inferior y laterales



Figura 3 – Montaje bandeja inferior y laterales

4.2. Montaje bandeja intermedia

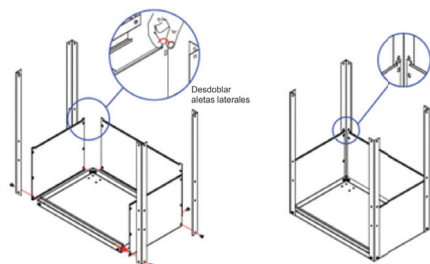

Figura 4 – Montaje bandeja intermedia

4.3. Montaje bandeja superior y mango

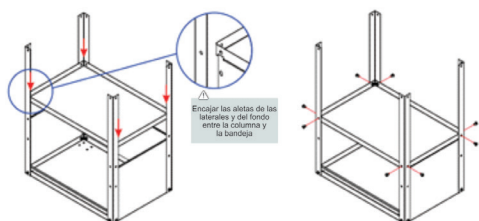

Figura 5 – Montaje bandeja superior y mango

5. Montaje cajonera

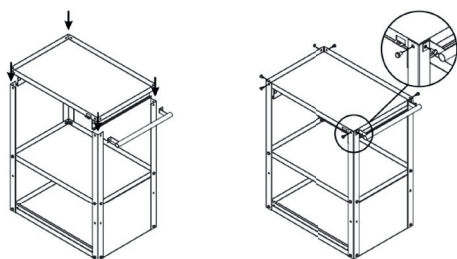

Figura 6 – Montaje cajonera

6. Montaje puertas y ruedas

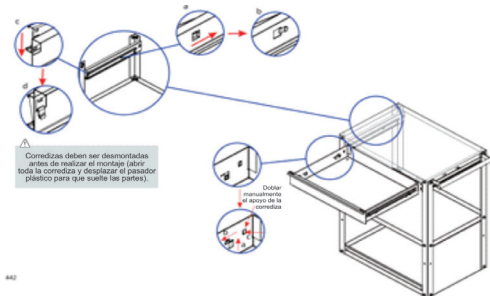

Figura 7 – Montaje puertas y ruedas

7. Montaje concluido

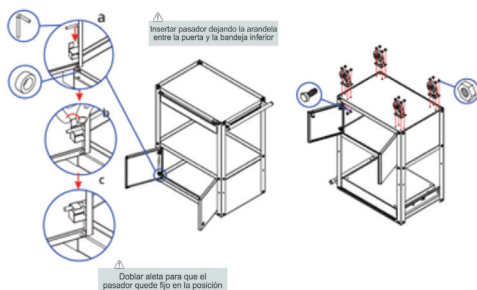
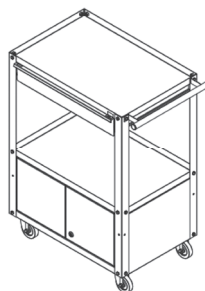

Figura 8 – Montaje concluido